

Thank you for purchasing a Snow Peak product. This product is a tent for camping. For safety, read the following instruction manual before use. Please keep it safe for future reference. Finally, if you find anything that you do not understand in the description or any problems with the product, please stop use immediately and contact the retailer or Snow Peak Customer Service.

Set Contents



Instruction manual
(this document) x 1



Repair pipe x 1



Rope with rope tensioner
Amenity Dome in 2: Forked end rope 4m
(13.1')x2, 2.5m (8.2')x4
Amenity Dome in 3: Forked end rope 5m
(16.4')x2, 2.5m (8.2')x6

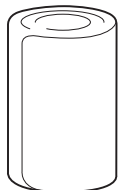

Inner tent x 1
Fly x 1



Peg case x 1



Pole case x 1



Cross pole x 2
Side pole x 1
Vestibule pole x 1

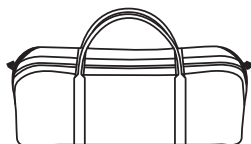

Carry bag x 1

Names of Parts

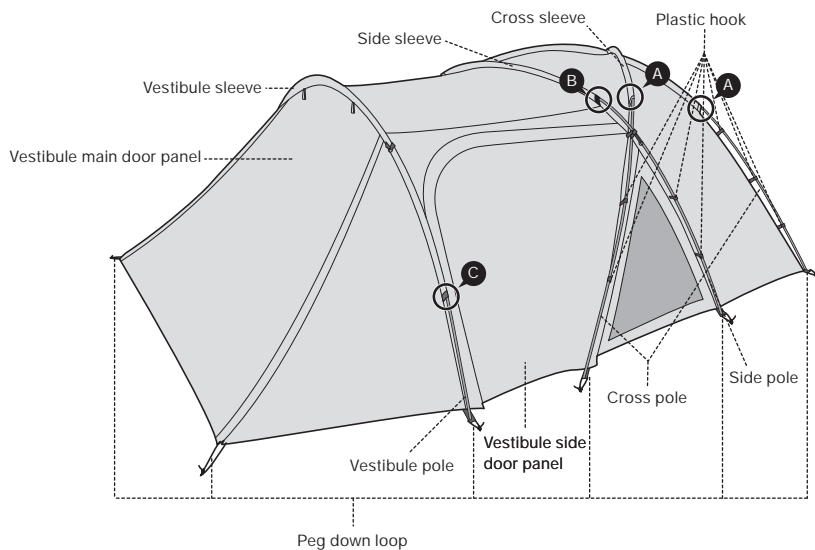

Pole Configuration

[For the Amenity Dome in 2]

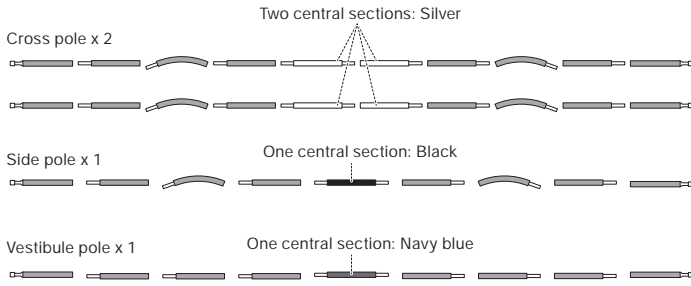

[For the Amenity Dome in 3]

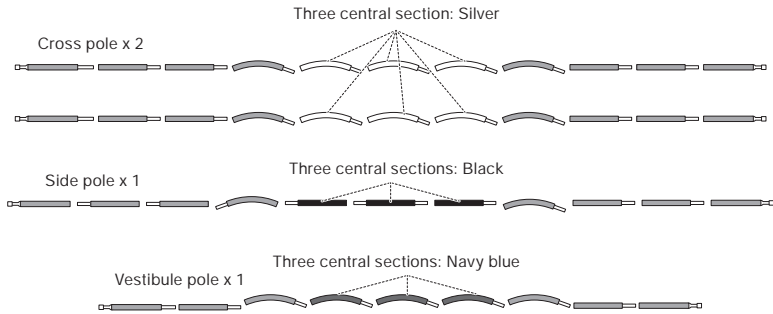

⚠ DANGER: Misuse could easily result in a serious accident or death.

The tent material is not flame-proof. Do not use combustion-based heat sources such as lanterns, stoves, or heaters, or open flames such as matches, candles, lighters, or cigarettes, inside the tent. The use of such heat or light sources inside a small enclosed space is hazardous and may result in fire, lack of oxygen, and monoxide poisoning, which are extremely dangerous.



Do not keep fuel or flammable items used to replenish the fuel inside the tent.



⚠ WARNING: Misuse could result in serious injury or death.

Before using the product, check each part for abnormalities. If there are abnormalities, take the product to the dealer or Snow Peak Customer Service for inspection or repair.

Always pay close attention to weather conditions. If bad weather (such as heavy rain, snowfall, strong winds, thunder, etc.) is expected, promptly cancel camping and evacuate to a safe location. In the event of bad weather or strong winds, check from time to time whether the pegs and the ropes are securely connected.



Do not bring heated items into the tent when they are at high temperatures. Inside the tent, very high temperatures may cause heatstroke or fire.

The temperature inside the tent will be high during warm weather, and there is a risk of heatstroke. Pay close attention to the temperature, particularly when children are asleep inside the tent.

Choose a flat, well-drained area with firm ground to pitch the tent. Choose a place with no chance of avalanches, landslides, wind gusts, or sudden flooding.

⚠ CAUTION: Misuse could result in injury to the user and/or damage to property.

This product is not intended to be in permanent use. If the tent is left in the sun for long periods of time, the colors of the materials may fade, or the fabric may deteriorate and lose its strength. Do not leave the tent set up permanently.

Sunlight can cause the surface of the product to heat up, potentially causing low-temperature burns. Please be careful.

Do not assemble or use this product close to a fire, fireworks, etc. When setting up or disassembling the product, make sure that there is no fire nearby. Flying sparks can create holes in the fabric.

Be sure to hold the tent firmly when assembling and disassembling. Unexpected accidents may occur due to the frame ends recoiling, etc., so ensure that the surroundings are safe, with no other people in the vicinity. Always assemble/disassemble this product with two or more people.

Secure the tent using pegs and ropes.

This product is made of a thin fabric, purchased may break if you pull the fabric excessively. Please pay attention to the building tape, rope, and pegs at your feet. If you are not careful, you may trip and fall, which may result in an unexpected accident or injury.

The inner tent has a loop for hanging small items. Please do not exceed 1kg (2.2 lbs) for all loops combined.

Setup procedure: To help ensure safety, this procedure should always be carried out by two or more people.

Please practice setting up and disassembling the tent repeatedly according to the following explanation in order to prepare to use it for camping. Make sure that you have all the accessories you need in advance. Inadequate setup and packing up may result in damage to the main unit or the frames and further lead to accidents. Please read this manual carefully before use.

- 1 Spread the tent body on a flat area.
Pay attention to the orientation of the vestibule main door panel. The side with the vestibule main door panel and the vestibule side door panel is the vestibule, which functions as the main entrance. It is important to predict the direction of wind and rain in advance and determine the orientation of the vestibule accordingly.
* Please make sure that all the building tapes are connected. If they are not connected, be sure to connect them before setup.
* Generally, position the vestibule downwind. If the vestibule is positioned upwind, wind and rain may enter, and when the door is opened, wind may suddenly rush in, potentially damaging the main body.

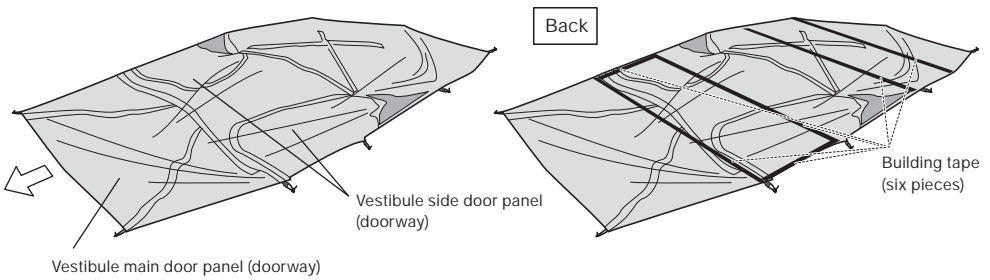

- 2 Extend the two cross poles (silver in the center) and connect the joints firmly.
* Be sure to insert firmly to eliminate any gaps where the poles join.

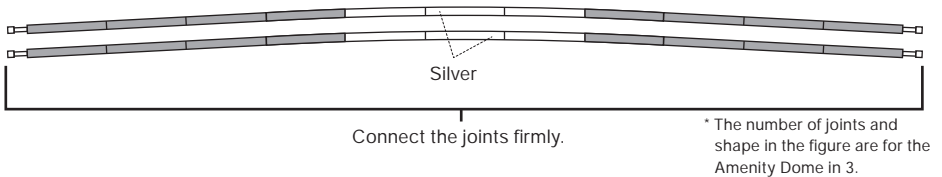

- 3 Check location A (see "Names of Parts") and pass the first cross pole through the cross sleeve.

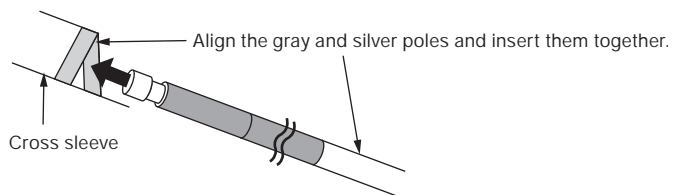

- ④ Similarly, pass the second cross pole through the other cross sleeve at the second location A (see "Names of Parts").

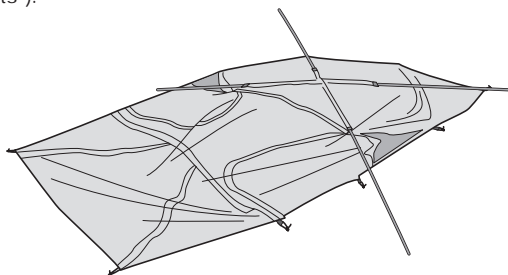

- ⑤ Insert the tip of the cross pole into the grommet with the gray peg-down loop.

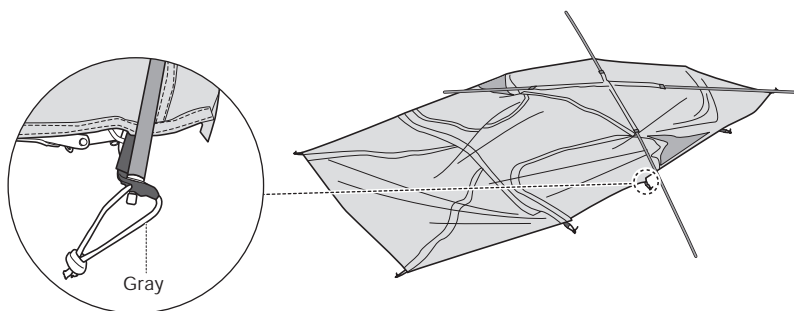

- ⑥ Insert the other end of the inserted cross pole into the grommet with the gray peg-down loop.

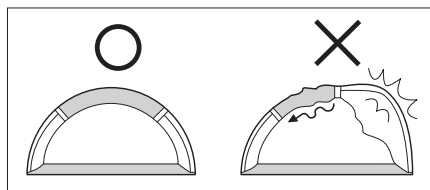
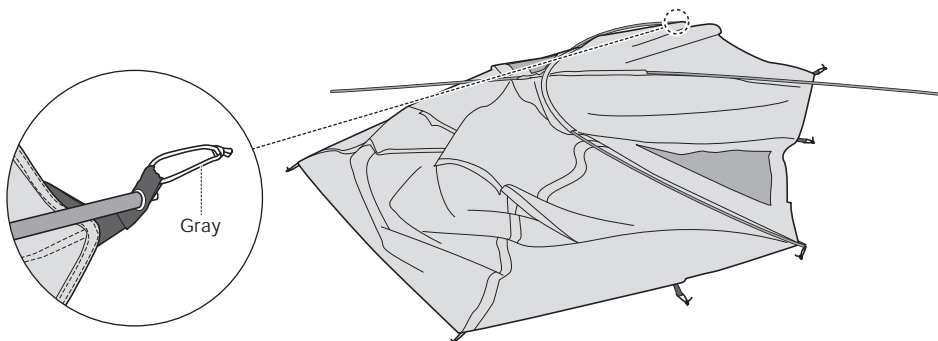

* Slowly insert the tip of the pole into the grommet while adjusting the main body to ensure the sleeve is centered. If you force it in from one side, the opposite side will bend significantly, which could cause the pole to break. Coordinate with the person on the other side while performing this step.

* When setting up the tent with the inner tent attached, the inner tent and flysheet may get caught inside. If the inner tent and flysheet are caught, do not force the tent up. Instead, remove the pole, release the areas where the inner tent and fly are caught, and then set the tent up again.

- 7 Similarly, insert the tip of the other cross pole into the grommet with the gray peg-down loop.

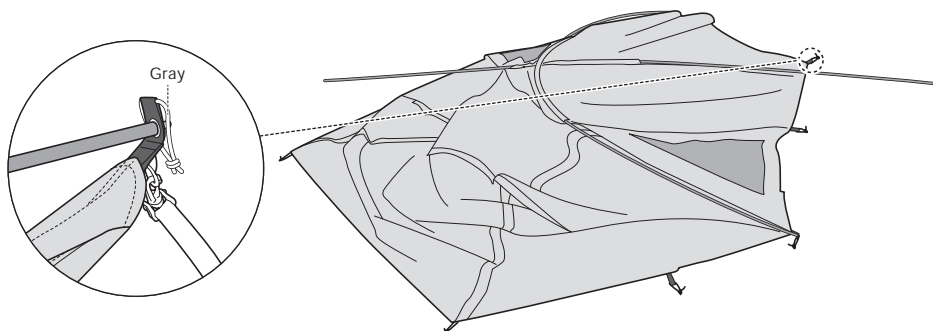

- 8 Insert the other end of the cross pole into the grommet with the gray peg-down loop and set up the tent.

* Leaving the door panel and side panel half open will enable air to blow in, which can inflate the tent and make it easier to set up.

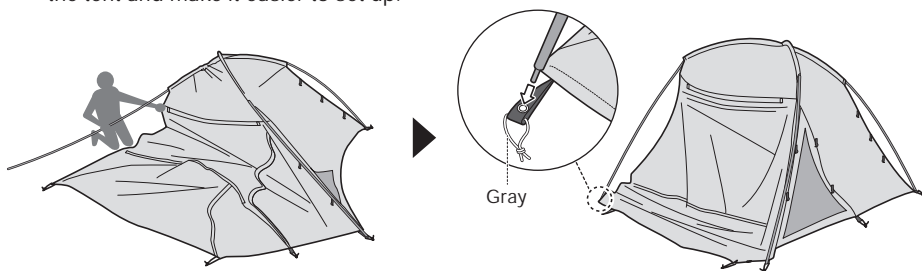

- 9 Extend the side pole (black in the center) and connect the joints firmly.

* Be sure to insert firmly to eliminate any gaps where the poles join.

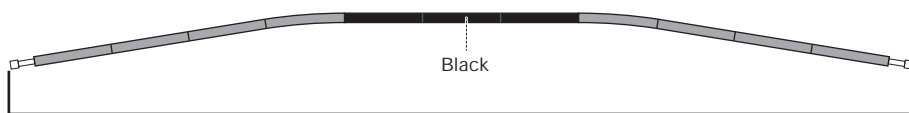

Connect the joints firmly.

* The number of joints and shape in the figure are for the Amenity Dome in 3.

- 10 Check location B (see "Names of Parts") and pass the side pole through the side sleeve.

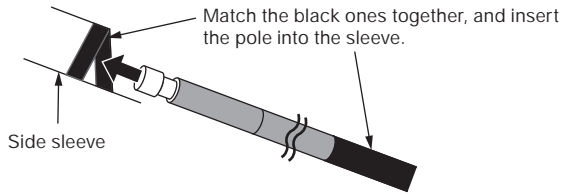

- 11 Once you have passed the side pole through the sleeve, insert the tip of the side pole into the grommet with the black peg-down loop. Insert the other end of the side pole in the same way.

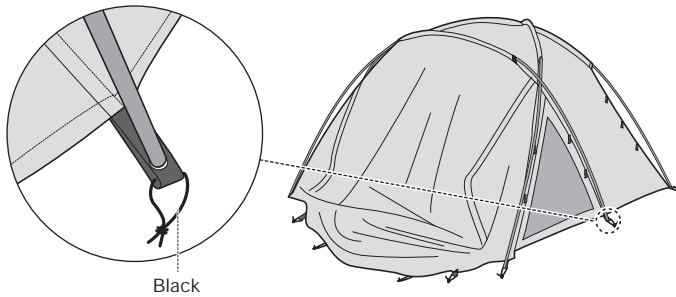

- 12 Extend the vestibule pole (navy blue in the center) and connect the joints firmly.
* Be sure to insert firmly to eliminate any gaps where the poles join.

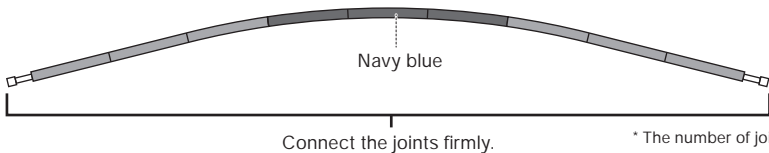

* The number of joints and shape in the figure are for the Amenity Dome in 3.

- 13 Check location C (see "Names of Parts") and pass the vestibule pole through the vestibule sleeve.

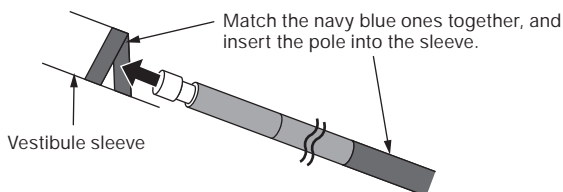

- 14 Once you have passed the vestibule sleeve through the sleeve, insert the tip of the vestibule pole into the grommet with the navy blue peg-down loop. Insert the other end of the vestibule pole in the same way.

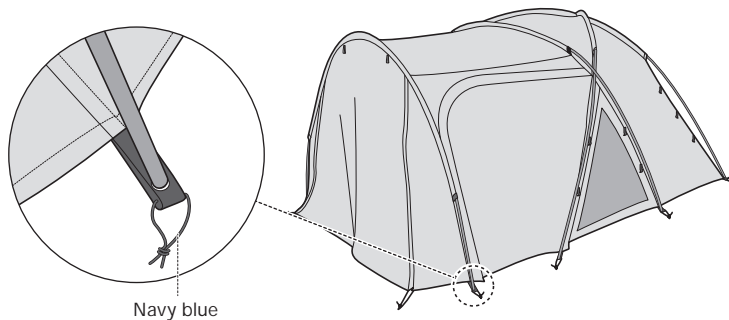

- 15 Hook the plastic hooks on the main body (eight locations for the Amenity Dome in 2, 14 locations for the Amenity Dome in 3) onto each pole. Pass the peg through the peg-down loops at the bottom and peg them down.
- * Drive the peg in all the way.
 - * Do not force the peg in, as doing so may cause it to bend or break. Drive the peg in gradually. If it encounters any obstacles such as stones, move it to a different location before continuing.
- 16 Gently pull each peg-down loop in the order shown below and peg it down ensuring there is no slack.

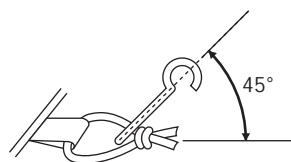
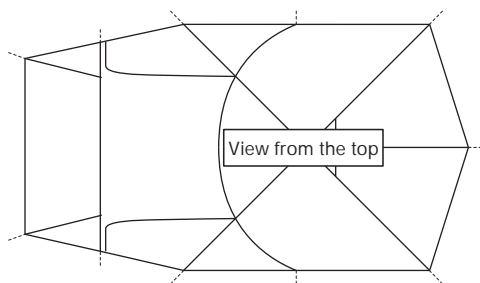

Drive the pegs into the ground at a 45° angle.

- 17 Stretch each rope and drive in the pegs.
 * The figure below is for the Amenity Dome in 3.

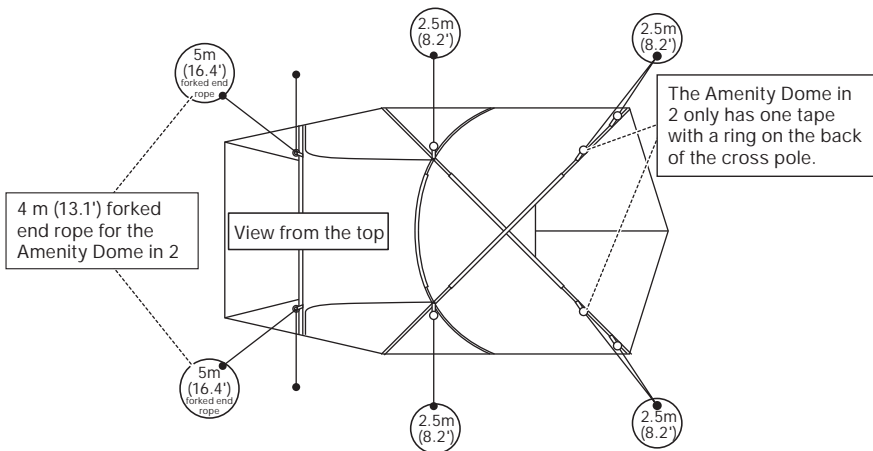

Attaching where the side poles intersect

1. Secure the two poles together using tape.

2. Wrap the tape around the sections where the poles intersect, then thread it through the tape and pull it tight.

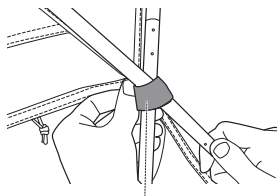
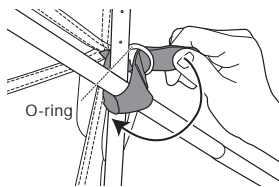

Align the hook and loop sides of the Velcro Tape to fasten them.

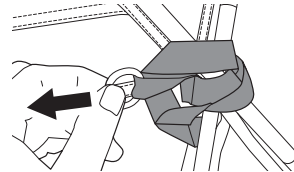

Attaching the tape with a ring

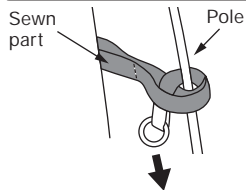

Wrap the tape around the pole, thread it through the tapes just before the stitching, and pull it tight.

Attaching the single rope

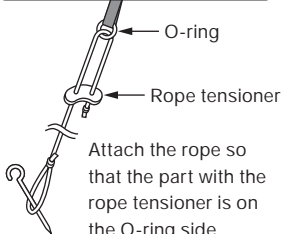

Attaching the forked end rope

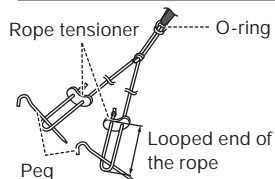

Pass the middle knot through the O-ring and attach it so that the end part is on the peg side.

- 18 Pull the rope tensioner to apply tension.
* Be careful not to pull the rope too tight. Pulling the rope too tight may put strain on the fly and cause damage.
- 19 Raise the ventilation bar and secure it using the Velcro. (one location)

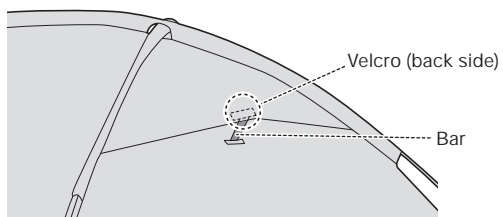

Attaching the inner tent

- 1 Check the front and back of the inner tent and spread it out inside the room.
Turn the inner tent side with the logo print to the vestibule side.

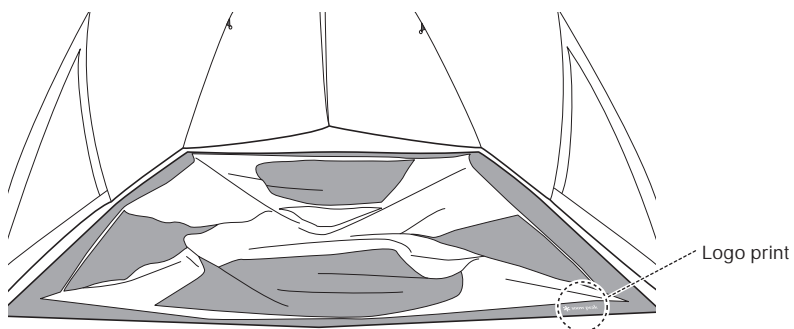

- 2 Hook the plastic toggle of the inner tent onto the plastic ring on the inside of the fly.

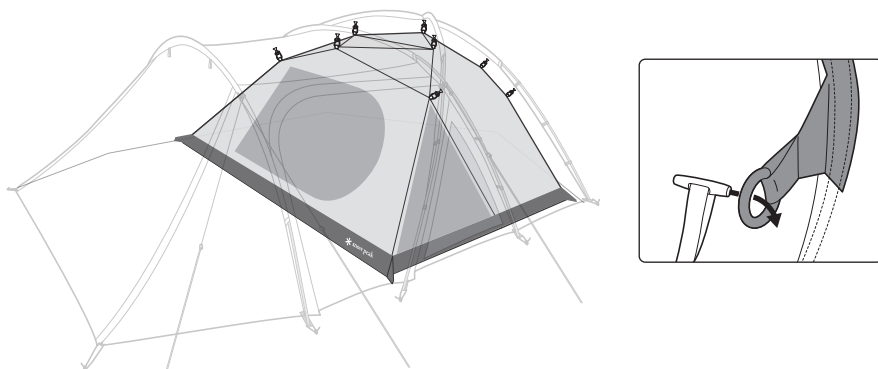

3 Attach each corner of the bottom in the order shown in the diagram below.

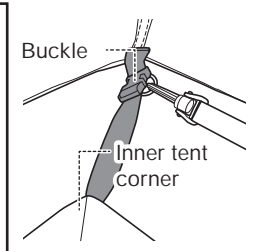
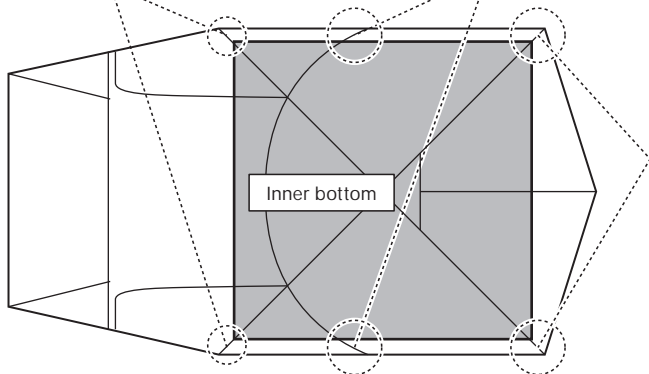
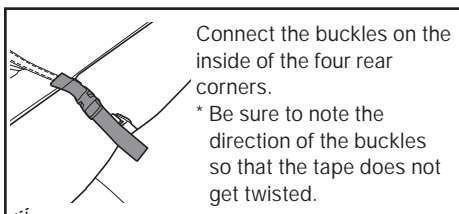
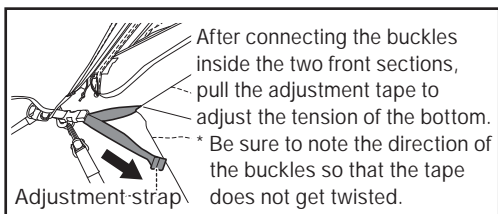

How to fold the fly and inner tent

How to fold the fly

(The same folding method applies even when the inner tent is attached.)

- 1 Flip the fly and tent over so that the underside is facing up.
If the inner tent is attached, open the front and rear zippers of the inner tent to release the air inside.
* Ensure that all the building tape is visible at this stage. If any building tape has come off, reattach it. This will make it easier to set up the tent next time.

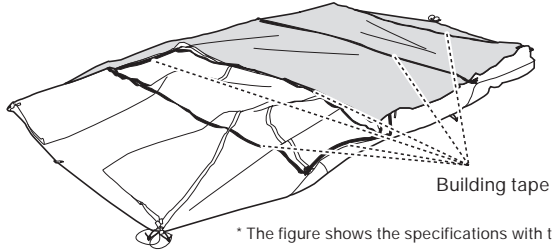

- 2 Fold the fly in half so that the left and right sides meet.

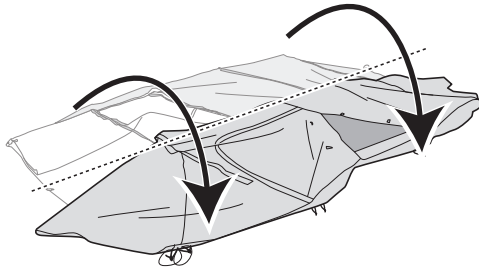

- 3 Fold both ends inward.

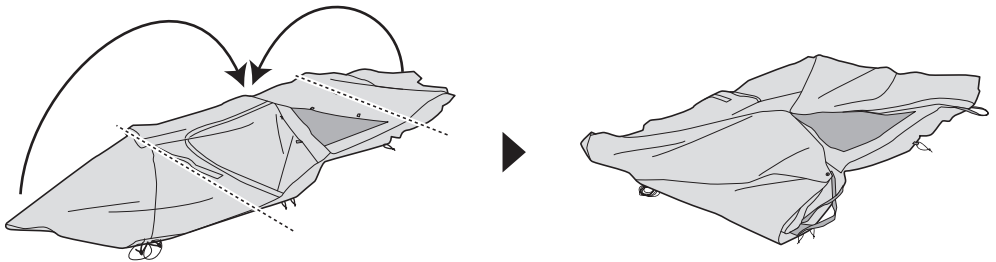

- 4 Fold it vertically to fit the width of the storage case, then roll it up in the direction of the arrow.

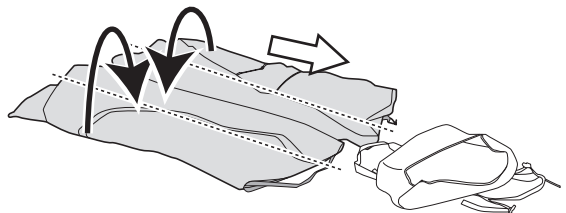

How to fold the inner tent

- 1 Completely remove it from the fly.
- 2 Spread out the inner tent and fold it inward from the corner without the doorway.

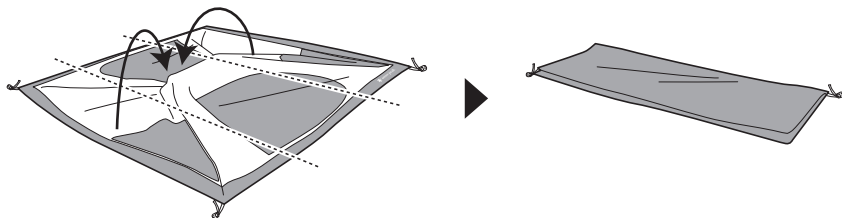

- 3 Fold it vertically to fit the width of the storage case, then roll it up in the direction of the arrow.

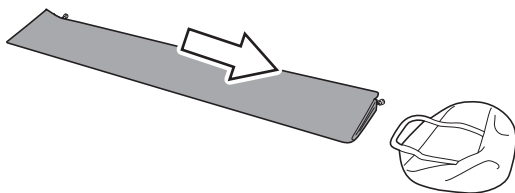

Precautions for disassembly and storage

Make sure that the product is sufficiently dry before storing it.

If the wind is strong, wait for it to subside before disassembling the product.

If you are using another tent, tarp, or similar product, be sure to remove it from the main body before starting to pack up.

Make sure that nothing is inside the tent and that all panels and windows are zipped before beginning disassembly.

Please ensure that all the building tapes are connected before taking down the tent. Connecting the belts makes it easier to peg down the tent next time.

Always fold the pole from near the center each time. If the pole is folded from the edge, it may cause the shock cord inside the pole to stretch or break, or the pole to bend or break.

Remove all pegs, clean them, and store them in the peg case with their heads facing down. Store all poles in the pole case. The pole should be stored with its head facing down in the pole case.

Storing these items while exposed may damage the main body fabric and the carry bag.

Condensation

Moisture suspended in the air rapidly cools down and turns into mist, which appears as condensation. Particularly in a confined space such as a tent or shelter, moisture from people inside is released into the air through breathing and sweating, which then turns into water vapor. This results in a higher concentration of water vapor compared to a typical room, increasing the likelihood of condensation forming. Condensation cannot be completely prevented, even with high-performance waterproof and breathable materials, depending on the usage conditions. To reduce condensation, frequently create steady ventilation while the tent is in use.

Water-repellent and waterproof functions

A combination of polyester fabric is used in this product. All fabrics are treated with a high-performance water-repellent finish, however, due to the nature of the materials, there may be slight differences in water-repellent performance (such as how water is repelled, and its durability). We appreciate your understanding.

The water-repellent finish will lose effectiveness after repeated use. When the water repellence decreases, please use a water-repellent spray purchased from your local outdoor gear retailer.

When using such sprays, please follow the product's instructions.

Materials with high waterproof capacity are used in this product. However, if the materials are in contact with pools of water on the ground for long periods, the water may be absorbed into the material, potentially resulting in discoloration.

The PU coating may be damaged by agricultural chemicals, which cause the water pressure resistance to decrease abnormally. Please note that the product cannot be subject to warranty if damaged by agricultural chemicals.

The logo may peel off due to the effect of the water repellent agent.

Regarding the effect of ultraviolet rays

A UV protection treatment has been applied to the fly material. The UV protection treatment will lessen the permeation of ultraviolet rays, which are harmful to humans, and slow the deterioration of the fly.

* The UV protection treatment does not completely shield humans from ultraviolet rays or stop the deterioration of the material's strength.

When the tent material is exposed to sunlight for long periods, color degradation or strength deterioration may occur. Do not leave the product assembled permanently.

If the material deteriorates due to ultraviolet rays and is badly damaged, it may become irreparable.

FAQ

Q: What can be done if a pole is broken while the tent is in use?

A: For an emergency treatment, use a repair pipe or splint, and secure with vinyl tape. Or fully disassemble the tent for repair.

Q: What can be done if the tent/tarp cloth is damaged or rips while the tent is in use?

A: Seal the area with packing tape on both sides or use a tent repair kit that can be purchased from your local outdoor gear retailer. When using a repair kit, read the instructions carefully.

Q: What can be done when the water-repellent finish degrades

A: The water-repellent finish will lose its effectiveness with repeated use. When the material's water repellence decreases, please use a water-repellent spray that can be purchased at your local outdoor gear retailer. When using such sprays, please follow the product's instructions.

Q: What can be done if mold develops on the tent material?

A: Wipe the affected area with a dry cloth and sterilize with alcohol. If the fabric has become colored due to mold, the color cannot be removed. Forceful removal of it may cause the fabric and coating to deteriorate, therefore, do not attempt to remove it.

Maintenance & storage

When using the product again after not using it for a long period of time, inspect the product and its included items. If you have any questions, please contact Snow Peak Customer Service.

A polyester fabric blend is used for this product. Considering the material characteristics, we adopted processing and color patterns that will result in less color migration. However, depending on storage conditions, slight color migration may occur. Do not store the product while it is wet. Before storage, the product should be cleaned and dried sufficiently. If the product is stored when wet, the build-up of mold, bad odors, color migration, and material deterioration will occur. Dry the product sufficiently in a breezy and shaded area and clean the surface with a soft brush before storing.

Clean and dry the surface of the poles before storing. If stored when wet, corrosion may occur, resulting in strength deterioration. Keep the joints clean and apply a small amount of silicone lubricant. Applying an excessive amount of lubricant will stain the fabric. Ensure that the cords inside the frame are not pulled unnecessarily.

When storing the frame, please fold them from the center outwards.

Please store in a well-ventilated area away from direct sunlight, high temperatures, and humidity. Using the zipper when it is covered with mud, sand or dust may cause wear or damage. Clean the zipper with a brush before use. Apply small amounts of silicone lubricant to the zipper regularly to ensure smooth movement. Applying an excessive amount of lubricant will stain the fabric.

Small areas of fabric damage can be fixed with repair tape. Please read the repair tape manual carefully before applying.

Depending on the conditions during use, the product material may deteriorate over a wide area, losing its durability and becoming irreparable.

Seam tape is pressure-capped at a temperature setting that prevents damage to the PU coating. However, it may peel off as it is used repeatedly. If peeling is found, set an iron at a low temperature and reattach only the peeling sections. Be aware that excessive heat will discolor or accelerate the deterioration of the fabric. Do not forcibly peel off the seam tape. If the PU coating peels off completely, it may be impossible to repair.

Sap cannot be easily removed. Do not set up this product under trees that frequently drop sap. If sap is forcibly removed using a solvent, etc., the fabric or coating may be damaged.

To maximize the longevity of this product, regularly check and maintain it (including all accessories such as pegs).

Warranty

Snow Peak has taken all possible measures to ensure every product is durable and functions correctly. If you find any product defects, please contact the retailer where you purchased the product or Snow Peak Customer Service. If there are apparent defects in the product's manufacturing, the defective product will be repaired or exchanged free of charge. In other cases, Snow Peak will repair the product for an appropriate fee. The decision to repair or replace the product will be at our discretion. Snow Peak will not repair the product for any damage that occurred due to the following:

1. Material deterioration caused by age
2. Damage caused by modifications or rough handling
3. Damage caused by inappropriate use not mentioned in the instruction manual
4. Damage caused by unexpected accidents
5. Any damage other than defects in the manufacturing process
6. Damage caused by dust or rust
7. Damage and defects caused by dismantling the product
8. Damage and defects caused by dropping, jolting or other shocks
9. Deterioration or failure of parts due to friction
10. Damage caused by the use of the product in combination with another manufacturer's products

Repair

If professional repairs are required, please contact the retailer where you purchased the product or Snow Peak Customer Service.

When you request repairs, please make sure that the product is dry and clean.

Please attach a memo or a tag indicating the necessary repair and please write details of how and when the damage occurred.

Transportation and repair costs are determined as follows.

1. Within warranty: The transportation cost (both ways) and repair cost will be covered by Snow Peak.
2. Outside warranty: The transportation cost (both ways) and repair cost will be covered by the customer.

Specifications

Amenity Dome in 2

Material: Fly / 75D polyester taffeta, PU coating waterproof rating: 1,800mm minimum, water-repellent finish, UV protection treatment (roof, wall), Inner tent / 68D polyester taffeta (wall), 210D polyester oxford, PU coating waterproof rating: 1,800mm minimum (bottom) Pole/A7001

Storage size: 64×21×27(h)cm / 25.2" ×8.3" ×10.6" (h)

Weight: 5.9kg / 13.0lbs

Capacity : 2 persons

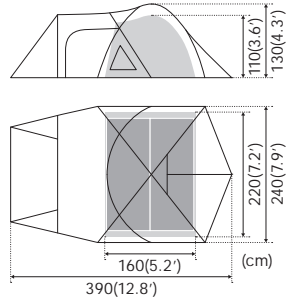

Amenity Dome in 3

Material: Fly / 75D polyester taffeta, PU coating waterproof rating: 1,800mm minimum, water-repellent finish, UV protection treatment (roof, wall), Inner tent / 68D polyester taffeta (wall), 210D polyester oxford, PU coating waterproof rating: 1,800mm minimum (bottom) Pole/A7001

Storage size: 71×22×26(h)cm / 28.0" ×8.7" ×10.2" (h)

Weight: 9.0kg / 19.9 lbs

Capacity : 3 persons

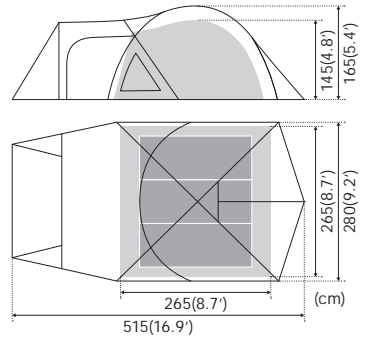

Snow Peak USA, Inc.

404 NW 23rd Avenue, Portland, Oregon 97210, USA

Tel. +1 (503) 461-0781 / Instagram. @snowpeakusa

Email. info@snowpeak.com / www.snowpeak.com

Snow Peak, Inc.

456, Nakanohara, Sanjo-Shi, Niigata 955-0147 Japan

Tel. +81 256-46-5858 / Fax. +81 256-46-5860

www.snowpeak.co.jp

MADE IN CHINA